

Ultracell®

'Quality in Every Language'

UC200-12

12V 200Ah (C₂₀)

12V 230Ah (C₁₀₀)

Deep Cycle Series

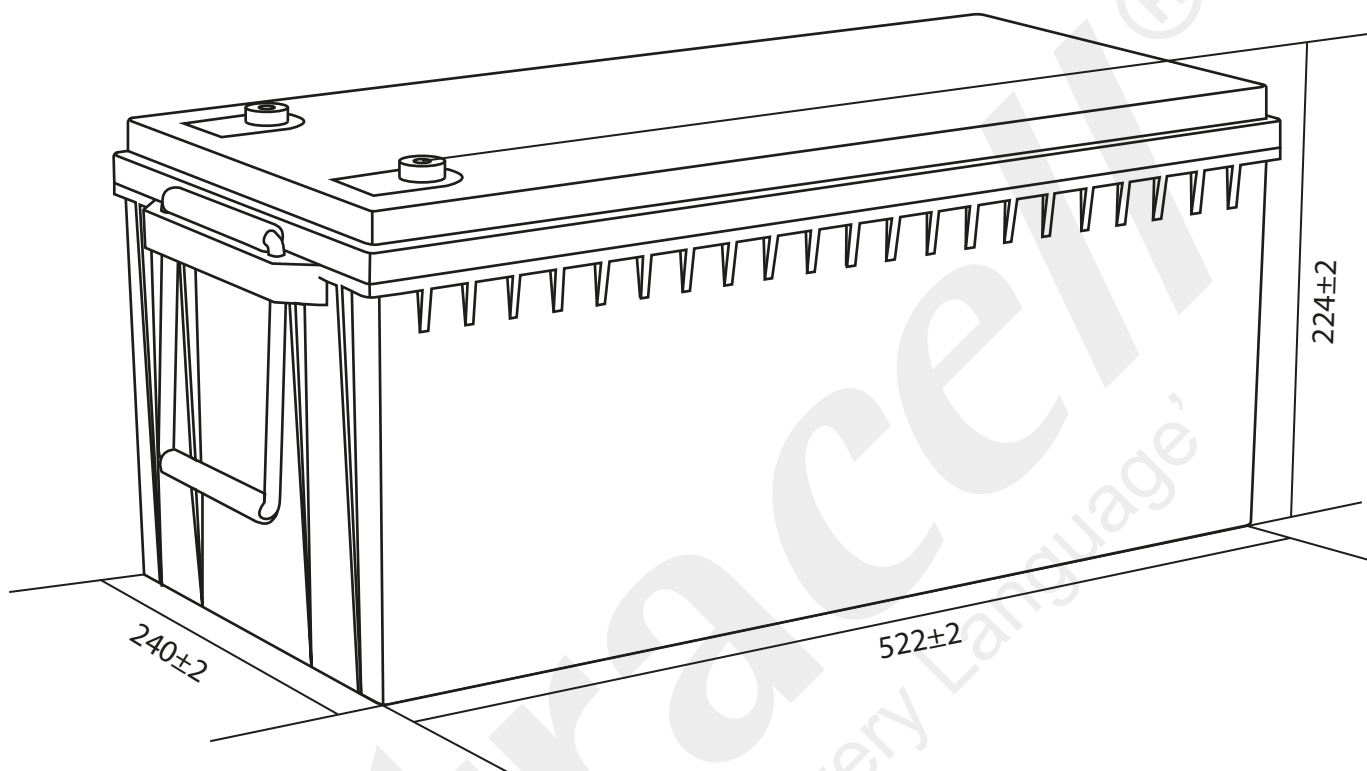

Technical Dimensions (mm)

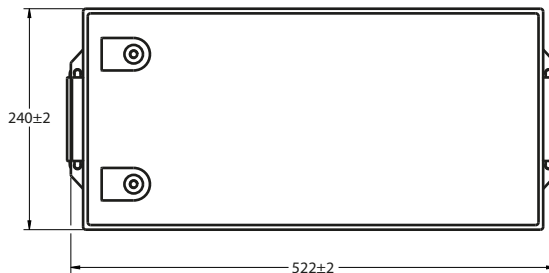
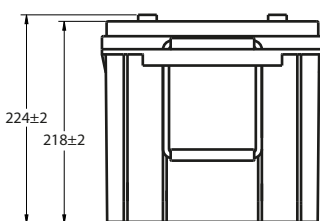
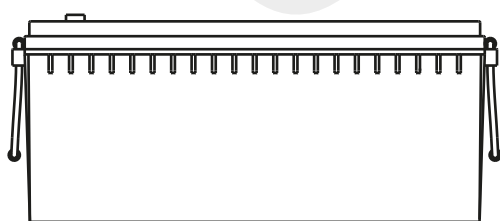

Image



Terminal Dimensions (mm)

Standard Terminal: F11

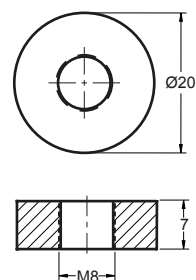

Technical Specification

| | | |
|-------------------------------------|----------------------------------|--|
| Output | Nominal Voltage | 12V |
| | Nominal Capacity (10HR) | 200Ah |
| Terminal Type | Standard Terminal | F11 |
| Container Material | Standard Option | ABS |
| | Flame Retardant Option (FR) | ABS (UL94:VO) |
| Rated Capacity | (100HR 1.80V/cell, 25°C) | 230 Ah/2.30A |
| | (20HR 1.80V/cell, 25°C) | 214.4 Ah/10.7A |
| | (10HR 1.80V/cell, 25°C) | 200 Ah/20.0A |
| | (5HR 1.75V/cell, 25°C) | 175.4 Ah/35.1A |
| | (3HR 1.75V/cell, 25°C) | 159 Ah/53.0A |
| | (1HR 1.60V/cell, 25°C) | 129.2 Ah/129.2A |
| Max Discharge Current | 2000A (5s) | |
| Internal Resistance | Approx 2.7mΩ | |
| Discharge Characteristics | Operating Temp Range | Discharge: -15 ~ 50°C Charge: 0 ~ 40°C Storage: -15 ~ 40°C |
| | Nominal Operating Temp Range | 25 ± 3°C |
| | Cycle Use | Initial Charging Current less than 60A. Voltage 14.4V ~ 15.0V @ 25°C Temp. Coefficient -30mV/°C |
| | Standby Use | No limit on initial charging current. Voltage 13.5V ~ 13.8V @ 25°C Temp. Coefficient -20mV/°C |
| | Capacity affected by Temperature | 40°C 103% 25°C 100% 0°C 86% |
| Design Floating Life at 20°C | 12 Years | |

Self Discharge

Ultracell® UC batteries may be stored for up to 6 months at 25°C and then a refresh charge is required. For higher temperatures the time intervals will be shorter.

Constant Current Discharge / Constant Power Discharge At 25°C (Amperes & Watts/Cell)

A = Amperes W = Watts

| F.V/TIME | 10 min | 15 min | 20 min | 30 min | 45 min | 60 min | 2 hours | 3 hours | 4 hours | 5 hours | 6 hours | 8 hours | 10 hours | 20 hours |
|-------------------|--------|--------|--------|--------|--------|--------|---------|---------|---------|---------|---------|---------|----------|----------|
| 1.85V/cell | 292.8 | 246.4 | 215.3 | 154.9 | 123.0 | 99.9 | 62.0 | 48.4 | 39.2 | 31.8 | 27.8 | 22.7 | 18.9 | 10.62 |
| 1.80V/cell | 546.3 | 464.5 | 410.3 | 297.7 | 238.1 | 193.8 | 120.9 | 94.5 | 76.7 | 62.5 | 54.9 | 44.8 | 37.4 | 21.3 |
| 1.75V/cell | 374.2 | 297.7 | 254.5 | 182.8 | 143.1 | 111.9 | 67.7 | 52.0 | 41.8 | 34.2 | 29.8 | 24.0 | 20.0 | 10.72 |
| 1.70V/cell | 688.8 | 552.9 | 477.6 | 347.1 | 274.6 | 215.8 | 131.1 | 101.2 | 81.5 | 66.9 | 58.6 | 47.5 | 39.6 | 21.4 |
| 1.65V/cell | 411.1 | 325.2 | 273.8 | 189.8 | 148.5 | 117.0 | 70.2 | 53.0 | 42.8 | 35.1 | 30.6 | 24.5 | 20.2 | 10.82 |
| 1.60V/cell | 747.5 | 598.1 | 509.6 | 358.5 | 283.6 | 224.9 | 135.6 | 102.8 | 83.2 | 68.6 | 60.1 | 48.3 | 40.0 | 21.6 |
| 1.70V/cell | 448.1 | 347.2 | 287.7 | 197.5 | 154.4 | 120.7 | 73.0 | 54.5 | 43.9 | 36.0 | 31.2 | 24.8 | 20.4 | 11.02 |
| 1.65V/cell | 803.4 | 633.9 | 532.5 | 371.7 | 294.1 | 231.5 | 140.7 | 105.4 | 85.2 | 70.1 | 61.3 | 48.9 | 40.3 | 22.0 |
| 1.65V/cell | 483.6 | 369.2 | 305.7 | 208.4 | 158.3 | 124.8 | 75.0 | 56.8 | 45.4 | 37.0 | 31.9 | 25.2 | 20.8 | 11.16 |
| 1.60V/cell | 860.8 | 669.7 | 563.0 | 390.3 | 300.3 | 238.5 | 144.2 | 109.6 | 87.9 | 72.0 | 62.6 | 49.6 | 41.1 | 22.2 |
| 1.60V/cell | --- | 394.8 | 325.6 | 220.0 | 165.0 | 129.2 | 77.6 | 58.5 | 46.8 | 38.2 | 32.6 | 25.4 | 21.0 | 11.22 |
| | --- | 707.6 | 593.6 | 408.1 | 310.2 | 244.9 | 148.1 | 112.4 | 90.3 | 74.0 | 63.8 | 50.0 | 41.5 | 22.3 |



Discharge Characteristics

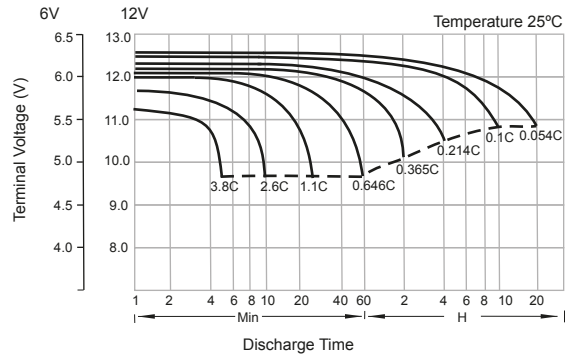

Float Charging Characteristics

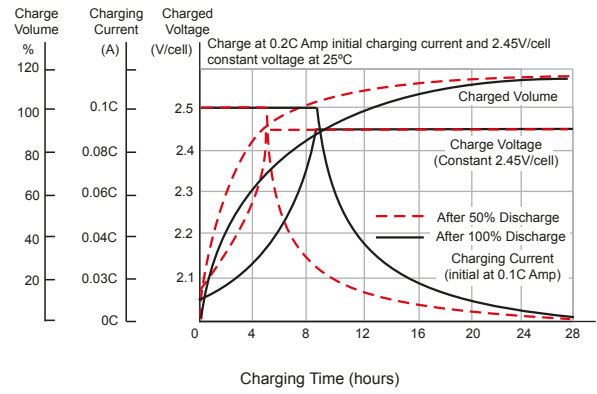

Temperature Effects in Relation to Battery Capacity

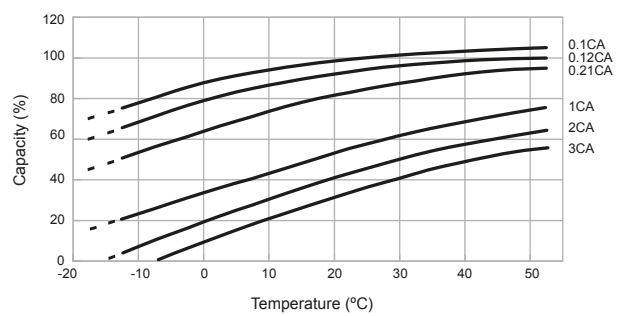

Cycle Life in Relation to Depth of Discharge

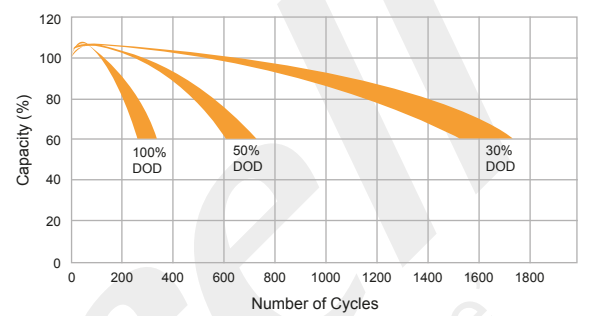

General Relation of Capacity vs. Storage Time

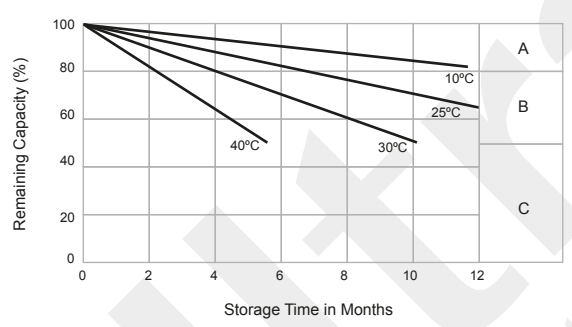

Floating Life on Temperature

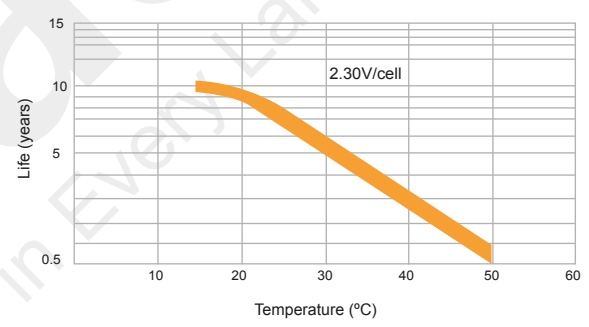

General Relation of Capacity vs. Storage Time (Notes)

- A) No supplementary charge required.
(Carryout supplementary charge before use if 100% capacity is required.)
- B) Supplementary charge required before use. Optional charging way as below:
 1. Charged for above 3 days at limited current 0.25CA and constant voltage 2.25V/cell.
 2. Charged for above 20 hours at limited current 0.25CA and constant voltage 2.45V/cell.
 3. Charged for 8 ~ 10 hours at limited current 0.05 CA.
- C) Supplementary charge may often fail to recover the capacity.
The battery should never be left standing till this is reached.

