

Instalación de estructura: L feet

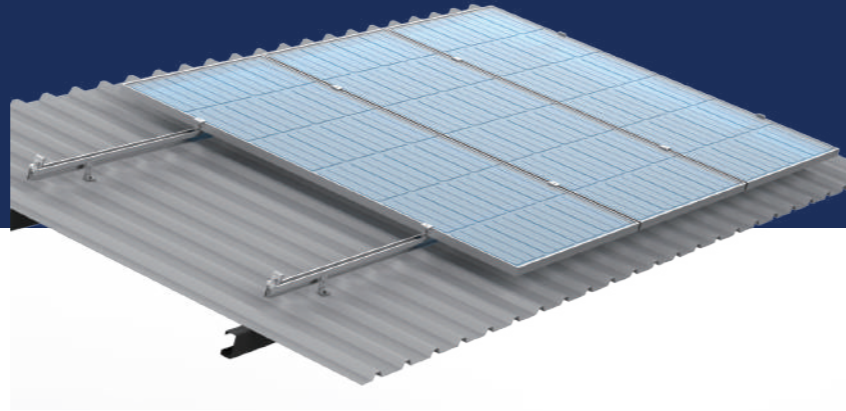

Materiales: aluminio anodizado 6005 T5 acero inoxidable 304
Velocidad del viento: hasta 45 m/s
Carga de nieve: hasta 50 cm



Paso 1

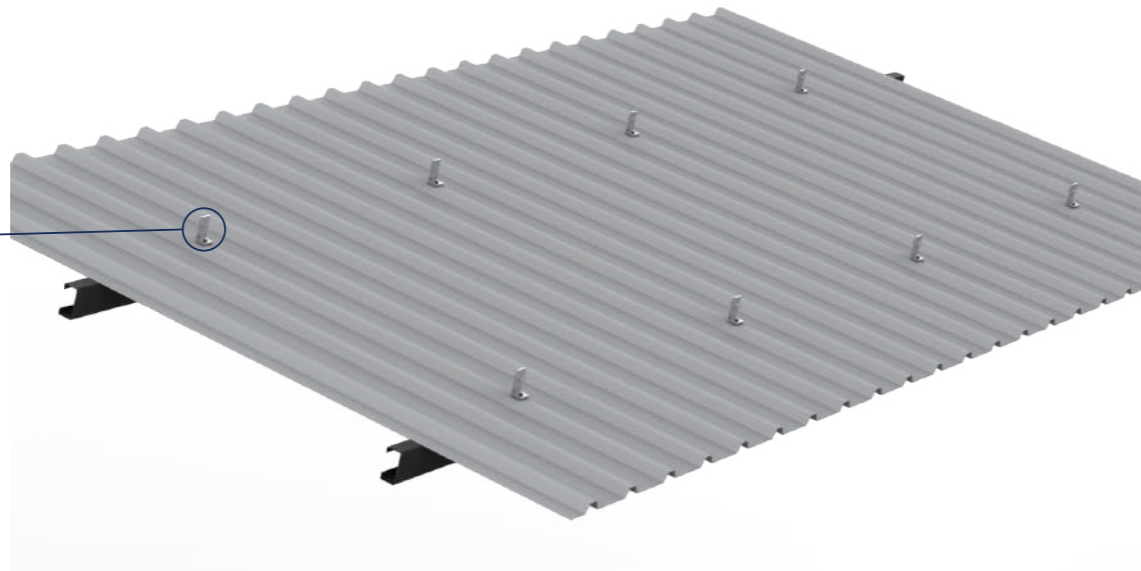
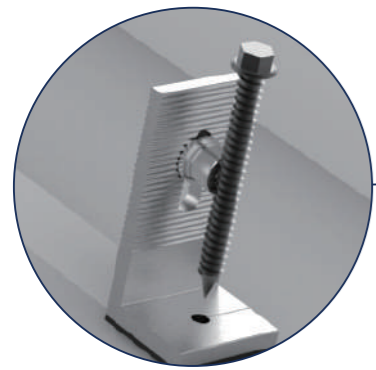

Fije el soporte en L en el techo de hojalata

Paso 2

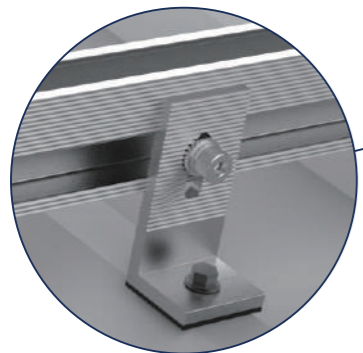

Fije el raíl en el soporte en L a través de la abrazadera

Paso 3

Fije el panel en el raíl con abrazadera de raíl y abrazadera intermedia

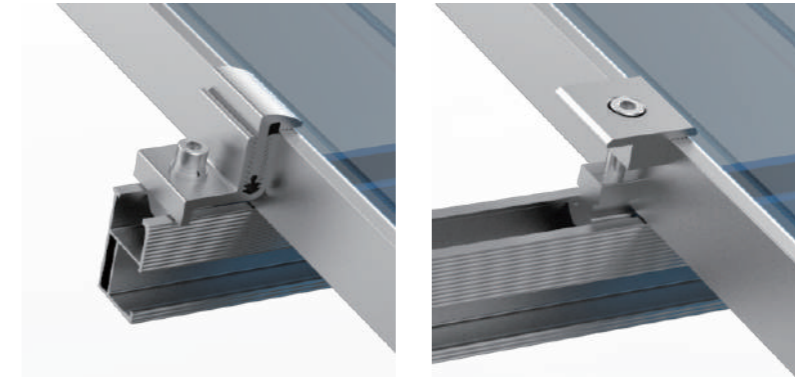

Muestra



ACCESORIOS



Herramientas y equipos de protección



Distancias instalación

1 panel

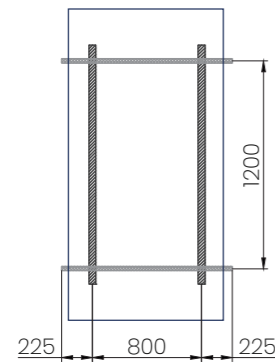

2 paneles

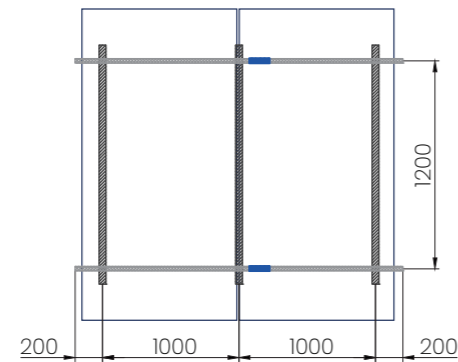

3 paneles

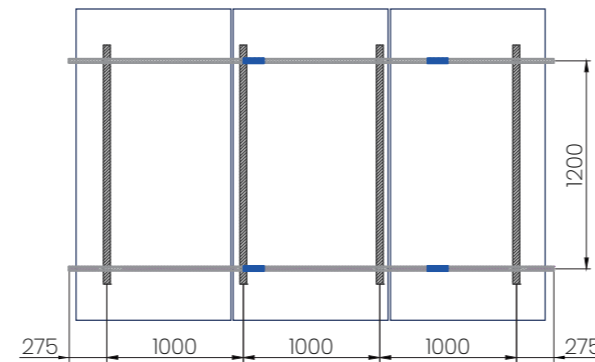

4 paneles

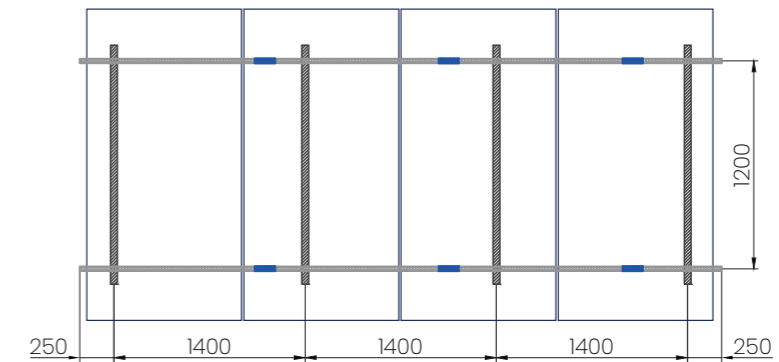

5 paneles

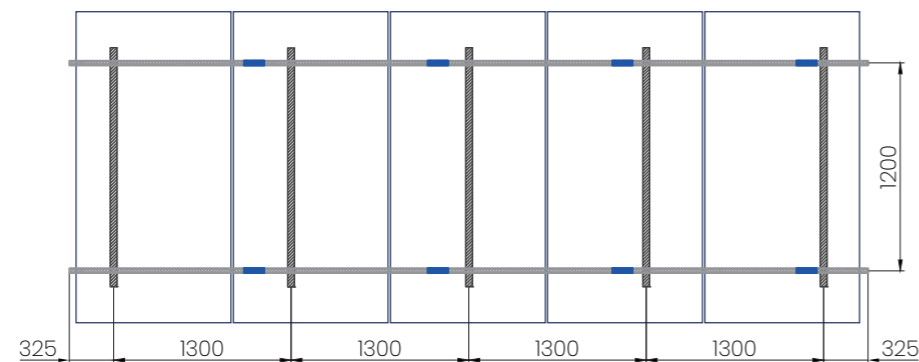

6 paneles

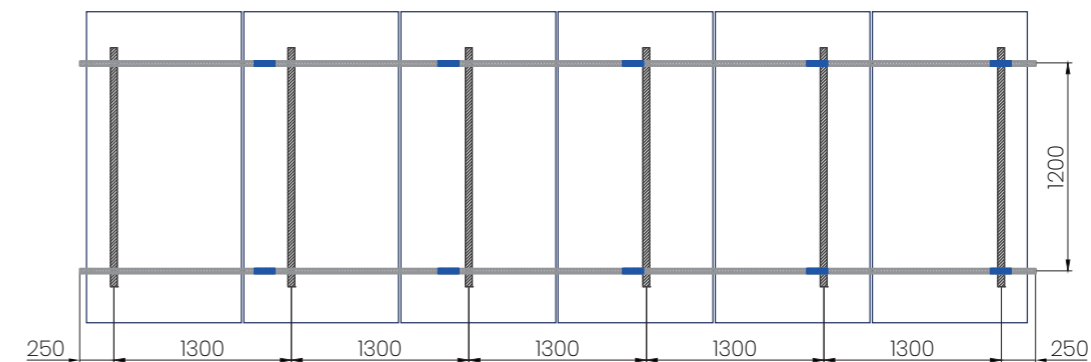

Accesorios

Cantidad/ paneles	L feet	Rail	Empalme de rail	Abrazadera intermedia	Abrazadera final
1 panel	4	2	-	-	4
2 paneles	6	4	2	2	4
3 paneles	8	6	4	4	4
4 paneles	8	8	6	6	4
5 paneles	10	10	8	8	4
6 paneles	12	12	10	10	4

Par de apriete

M8	10-12Nm
M10	24-28Nm
ST6.3	8-10Nm

Certificado

